



KAVASS SECURITY TECH LIMITED

Provide human with safe area

Terminal 1

Fixed Bollard

KAVASS fixed bollards are designed for vehicle access control requirement of residential area, commercial and retail premises, walk street, plaza etc. Offered in 2 designs: in-ground for installation into a concrete footing or surface mounted for bolted installation.



APPLICATION

1. Retail Shopping Centres
2. Hotel
3. Office Building
4. Pedestrian Zone
5. Residential streets

ADVANTAGES

1. High resistance to corrosion and weathering.
2. Economical and easy to install.
3. Low-cost installation and maintenance.
4. Polished finish or Galvanized + powder coated finish as standard.
5. 3M diamond level reflective tape for warning.
6. Size Color and material can be customized.



type 1



Features

- Bolt Down - Surface Fixed
- Easy installation and maintenance
- Available in a variety of sizes
- Galvanized and powder coated as standard.
- Hot galvanized only or powder coated only option available.
- Bollards come with semi-domed top cap. Flat and mitred top cap option available.
- Requires 4*M10 Anchor Bolts, 100mm in depth
- OEM is also welcomed



Optional

This product can be customized with a wide range of optional fixtures. If you have any further requirements, get in touch.



Flat top Mitred top Groove Molded top cap for 90mm and 114mm Round base plate

Item No.	KVS-FB(S)-76.1000.2-4	KVS-FB(S)-89.1000.2-4	KVS-FB(S)-101.1000.2-4	KVS-FB(S)-114.1000.2-4	KVS-FB(S)-140.1000.2-4	KVS-FB(S)-168.1000.2-4
Diameter	76	89	101	114	140	168
Thickness	2 / 3	2 / 3	2 / 3	2 / 3	2 / 3	2 / 3
Height	1000	1000	1000	1000	1000	1000
Base plate size	L156*W156*T6	L156*W156*T6	L156*W156*T6	L156*W156*T6	L156*W156*T6	L156*W156*T6
Material	Carbon steel					
Surface finish	Galvanized and powder coated as standard. Hot galvanized only or powder coated only option available.					
Others	Other size can be customized on request					

type 2



Features

- Root fixed into ground
- Available in a variety of sizes
- Finished with galvanized and powder coated. Hot galvanized only or powder coated only option available.
- Bollards come with semi-domed top cap. Flap and mitred top cap option available.
- OEM is also welcomed



Optional

This product can be customized with a wide range of optional fixtures. If you have any further requirements, get in touch.



Flat top Mitred top Groove Molded top cap for 90mm and 114mm Round base plate

Item No.	KVS-FB(I)-76.1020.2-0	KVS-FB(I)-89.1300.2-0	KVS-FB(I)-101.1300.2-0	KVS-FB(I)-114.1300.2-0	KVS-FB(I)-140.1300.2-0	KVS-FB(I)-168.1300.2-0
Diameter	76	89	101	114	140	168
Thickness	2 / 3	2 / 3	2 / 3	2 / 3	2 / 3	2 / 3
Height	700+300	1000+300	1000+300	1000+300	1000+300	1000+300
Material	Carbon steel					
Surface finish	Finished with galvanized and powder coated. Hot galvanized only or powder coated only option available.					
Others	Other size can be customized on request					

type 1



Features

- Bolt Down - Surface Fixed
- Easy installation and maintenance
- Available in a variety of sizes
- High quality 304 grade stainless steel or 316 grade stainless steel.
- Bollards come with flap top cap. Semi-domed and Mitred top cap option available.
- OEM is also welcomed

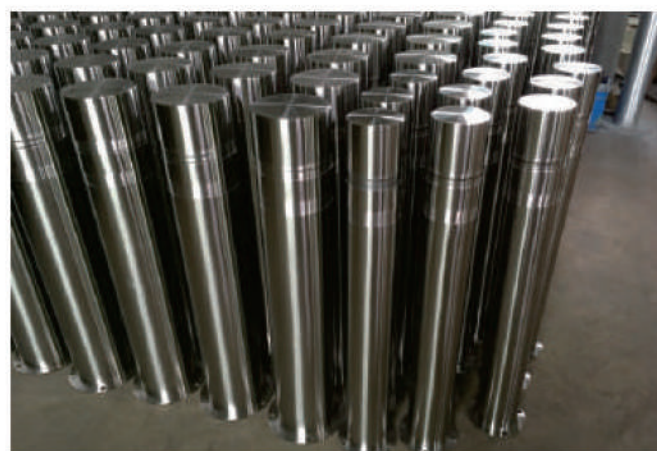

Optional

This product can be customized with a wide range of optional fixtures. If you have any further requirements, get in touch.



Mitred top Semi-dome top Grooves Reflective tape Decoration cover Customized design

Item No.	KVS-FB(S)-76.1000.2	KVS-FB(S)-89.1000.2	KVS-FB(S)-101.1000.2	KVS-FB(S)-114.1000.2	KVS-FB(S)-140.1000.2	KVS-FB(S)-168.1000.2
Diameter	76	89	101	114	140	168
Thickness	2 / 3	2 / 3	2 / 3	2 / 3	2 / 3	2 / 3
Height	1000	1000	1000	1000	1000	1000
Base plate size	D156*T6	D170*T6	D182*T6	D194*T6	D220*T6	D250*T6
Material	304 Grade / 316 Grade					
Surface finish	High quality stainless steel polished as standard					
Others	Other size can be customized on request					

type 2



Features

- Root fixed into ground
- Available in a variety of sizes
- High quality 304 grade stainless steel or 316 grade stainless steel.
- Bollards come with semi-domed top cap. Flap and mitred top cap option available.
- OEM is also welcomed



Optional

This product can be customized with a wide range of optional fixtures. If you have any further requirements, get in touch.



Mitred top Semi-dome top Grooves Reflective tape Base ring Customized design

Item No.	KVS-FB(I)-76.1020.2	KVS-FB(I)-89.1300.2	KVS-FB(I)-101.1300.2	KVS-FB(I)-114.1300.2	KVS-FB(I)-140.1300.2	KVS-FB(I)-168.1300.2
Diameter	76	89	101	114	140	168
Thickness	2 / 3	2 / 3	2 / 3	2 / 3	2 / 3	2 / 3
Height	700+300	900+300	900+300	900+300	900+300	900+300
Material	304 Grade / 316 Grade					
Surface finish	High quality stainless steel polished as standard					
Others	Other size can be customized on request					

type 1 LED Lighted bollard



Features

- Set Of 3 3W 24V Low Voltage LED.
- Made from Stainless Steel High Quality Finish.
- Energy Saving Low Running Cost Beautiful CoolWhite Light.
- Two types available: In-ground bollard set with concrete and surface mount bollards set with bolts.

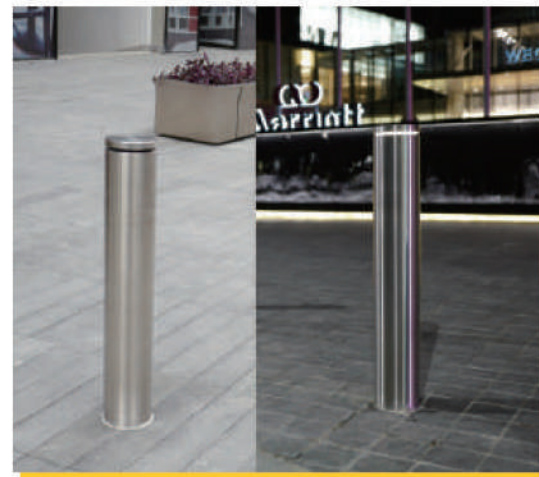

type 2 Solar lighted bollard



Features

- Solar Powered, No need for electricity or wires.
- Automatically Turns On in Dark.
- Runs For 6-8 Hours Every Night.
- 10mm width acrylic lighted part.
- Rooted to concrete as standard. Surface mounted flange on request.
- High grade stainless steel (304 or 316 grade)

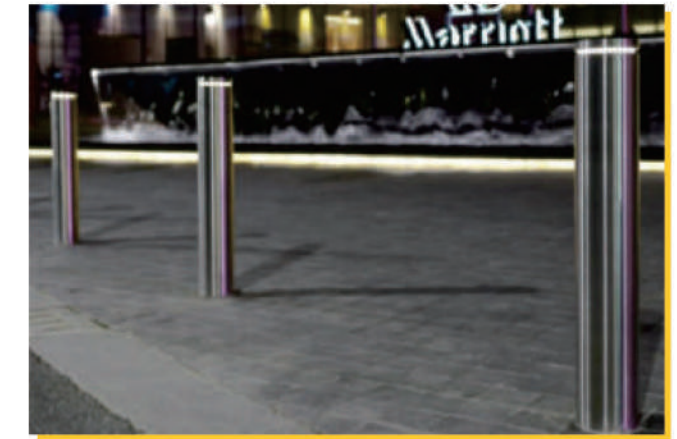

Item No.	KVS-FB(L)-114.1100.3	KVS-FB(L)-140.1200.5
Diameter	114	140
Thickness	3	5
Height	900+200	900+300
Material	304 Grade/316 Grade	
Surface finish	High quality stainless steel polished as standard	
LED	24V low voltage LED light	
Others	Other size can be customized on request	

Item No.	KVS-FB(SL)-114.1100.3	KVS-FB(SL)-140.1200.5
Diameter	114	140
Thickness	3	5
Height	900+200	900+300
Material	304 Grade/316 Grade	
Surface finish	High quality stainless steel polished as standard	
Solar panel	5.5V 100MA 0.2W polysilicon	
Battery	3.7V 1800mHA nickel-hydrogen battery	
LED Lights	0.5W	
Charging time	8 hours in the sun	
Lighting time	6-8 hours	
Light colour	White	
Others	Surface mount type optional; Other sizes are available on request.	

LED lighted bollard control box(Optional)

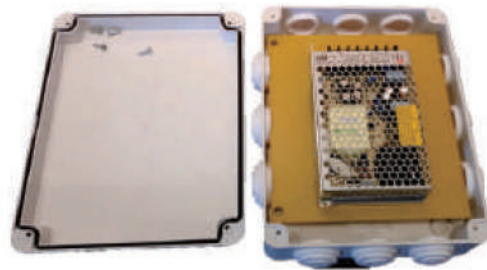

- LED Lighted bollard control box
- Size: 200*250mm
- Voltage convertor. From 220V/110V to 24V.
- Meet international standard
- Max control 20 units bollards



Removable Bollard



Removable bollards allow for period access requirements. Designed for vehicle access control requirement of residential area, commercial and retail premises, walkstreet, car show room, plaza etc, while preserving sightlines and unobstructed pedestrian flow. Easily remove bollards to allow temporary passage of service, delivery, or emergency vehicles, or increase accessibility of plazas, parking lots, and other spaces for seasonal or event use.

APPLICATION

1. Plazas
2. Parking lots
3. Retail Shopping Centres
4. Hotel
5. Office Building
6. Pedestrian Zone

ADVANTAGE

1. High resistance to corrosion and weathering
2. High security anti-theft locking mechanism
3. Economical and easy to install
4. Lifted and removed easily
5. Reflective tape for warning
6. High security anti-theft locking mechanism



type 1

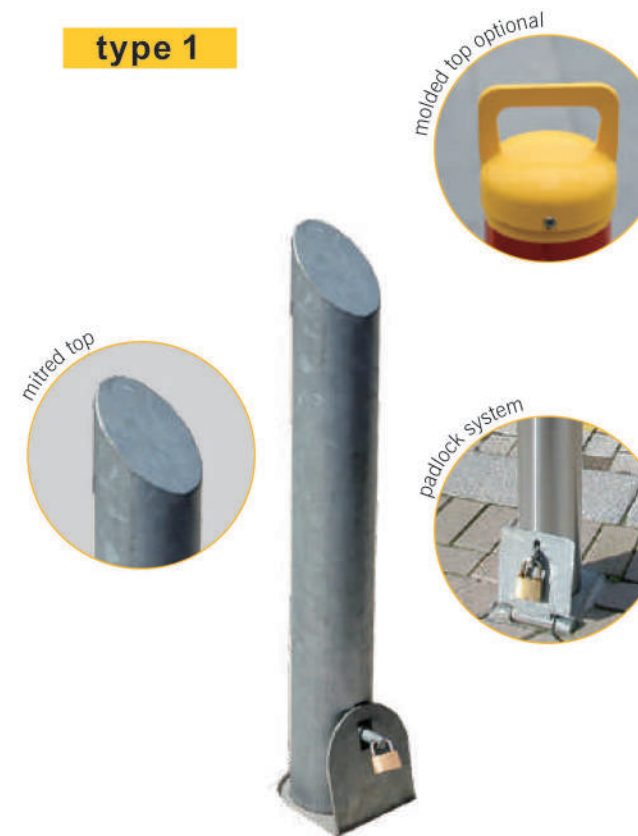

Features

- Effective padlock system
- Low cost installation and maintenance
- Mitred top as standard
- Hot dip galvanized as standard

Features

- Flap top or molded top cap option available
- Powder coated option available
- Reflective tape option available
- Different size option available

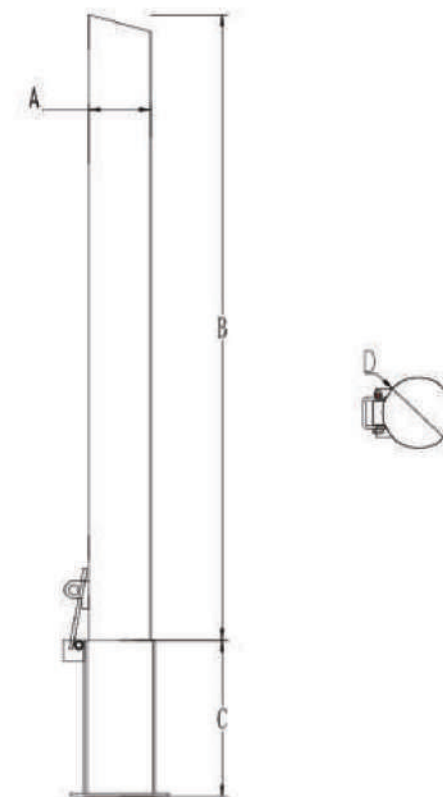
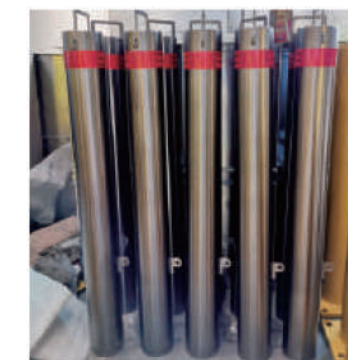

Specification		
Item No.	KVS-REB(IP)-89.900.3-0	KVS-REB(IP)-140.1200.3-0
Diameter	89	140
Thickness	3	3
Height	900	1200
Material	Carbon steel	
Surface finish	Finished with hot galvanized. Powder coated only option available.	
Others	Other size can be customized on request. 304, 316 grade stainless steel option available.	

type 2



Features

- Effective pad lock system.
- Low-cost installation and maintenance.
- Hot galvanized + powder coated finish or High quality Stainless Steel Polished finish as standard.
- Post holders and hangers available for storing posts when idle.

Optional

- Material: Carbon steel/304SS/316SS
- Reflective tape: Different colour
- Post holders and hangers
- Other colours and sizes on request.

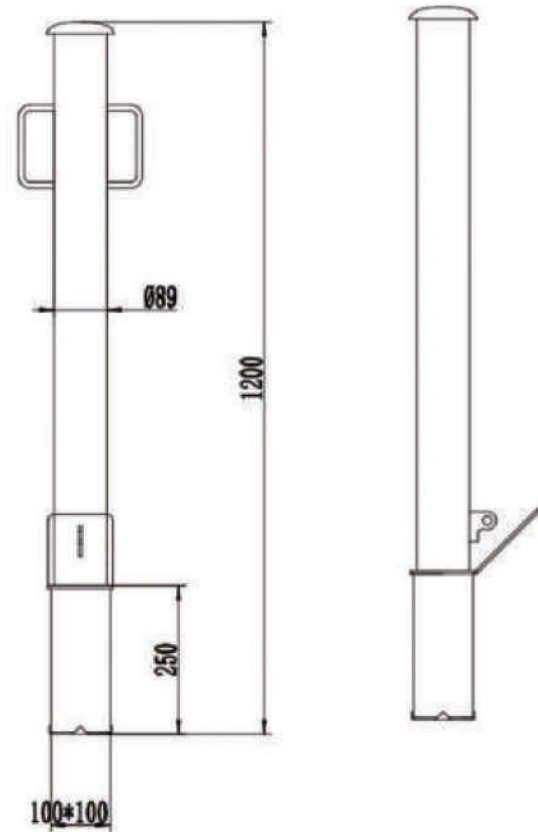

Technical Specs-type 1

Model Name	KVS-REB(IP)-89.965.3
Diameter	89mm
Height	965+250mm
Thickness	3mm
Material	Carbon steel/304SS/316SS
Handle Type	Standard
Lock system	Padlock
Colour	Can be customized
Surface Treatment	Carbon steel: Hot galvanized + powder coated 304SS/316ss: High quality Stainless Steel Hairline Polish

type 3

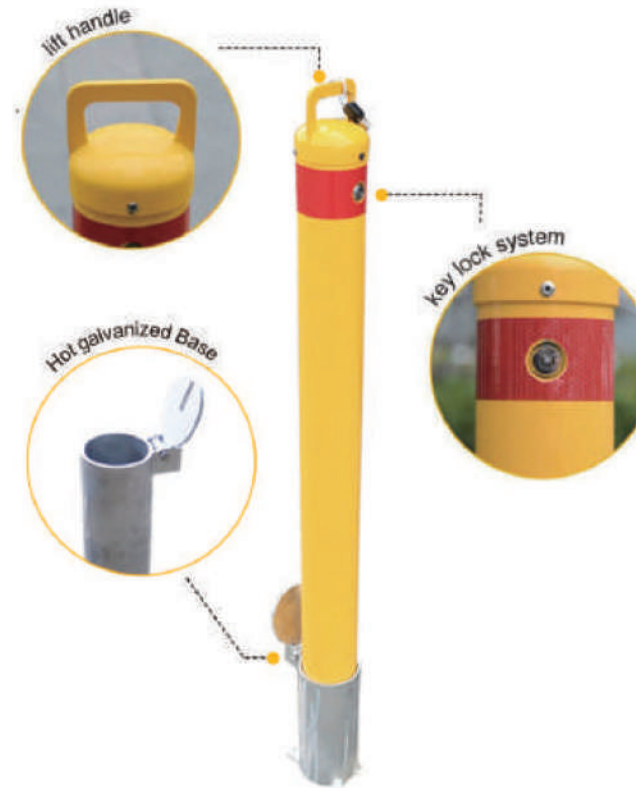

Features

- Internal locking mechanism for extra security.
- Comes set with the Sleeve that can be easily cored into the ground or set in concrete.
- Hot galvanized + powder coated finish or High quality Stainless Steel Polished finish as standard.
- Post holders and hangers available for storing posts when idle.

Optional

- Material: Carbon steel/304SS/316SS
- Reflective tape: Different colour
- Post holders and hangers
- Other colours and sizes on request.

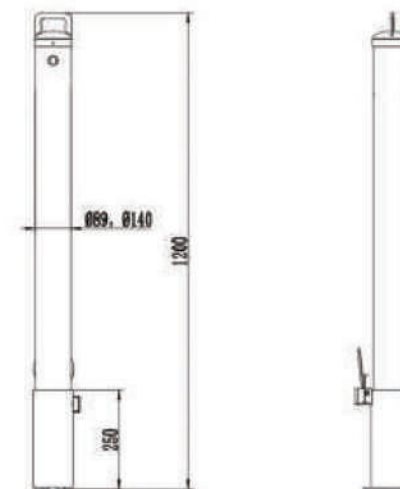
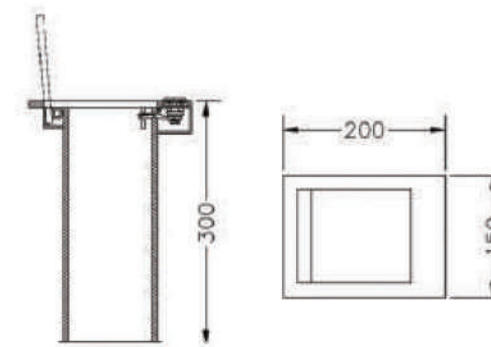

Specification

Item No.	KVS-REB(IK)-89.900.3-0	KVS-REB(IK)-140.1200.3-0
Diameter	89	140
Thickness	3	3
Height	900	1200
Material	Carbon steel	
Surface finish	Finished with galvanized and powder coated.	
Others	Other size can be customized on request. 304, 316 grade stainless steel option available.	

type 4



Features

- Surface mounted
- No extra depth digging
- Easy installation
- Hot dip galvanizing and spraying
- Can be customized of 304SS or 316SS

Optional

- Reflective tape: Colour & Quantity
- Base Plate • Fixings



type 5



Features

- Lifted easily
- Built-in lock system
- Economical and easy to install
- High resistance to corrosion and weathering
- 3M diamond level reflective tape for warning.
- Excellent surface treatment-- Hairline polish

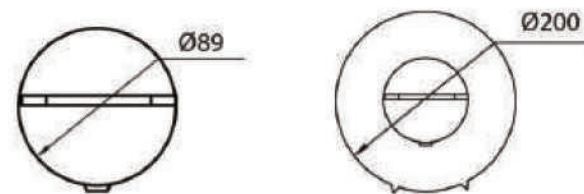
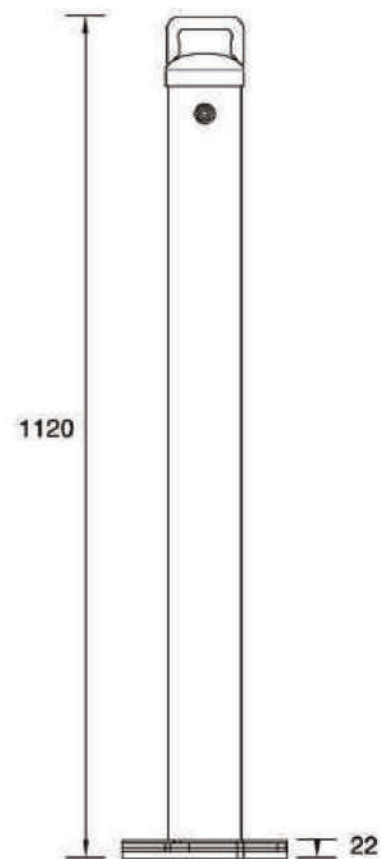

Technical Specs-type 1	
Model Name	KVS-REB(S)-89.900.3
Diameter	89mm
Height	900mm
Thickness	3mm
Material	Carbon Steel/304SS/316SS
Handle Type	Standard
Lock system	Side Key-lock
Colour	Yellow/Black/Sliver
Surface Treatment	Carbon Steel: Hot galvanizing and powder coated 304SS/316SS: Hairline Polish

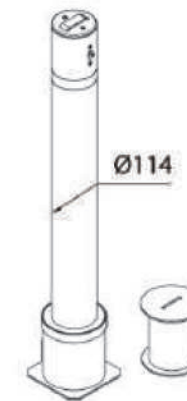
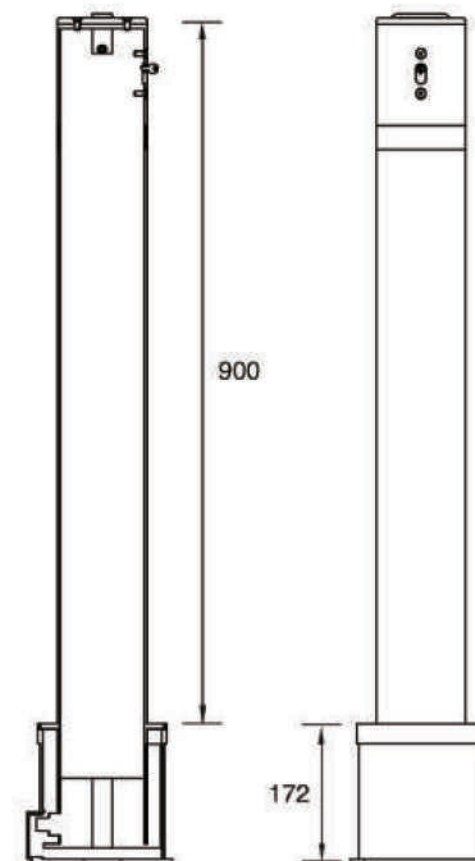

Technical Specs-type 1	
Model Name	KVS-REB(IO)-114.900.3
Diameter	114mm
Height	900mm
Thickness	3mm
Material	Carbon Steel/304SS/316SS
Handle Type	Standard
Lock system	Side Key-lock
Colour	Yellow/Black/Sliver
Surface Treatment	Carbon Steel: Hot galvanizing and powder coated 304SS/316SS: Hairline Polish



Manual Retractable Bollard



For over a decade **KAVASS** has been recognised as leader in retractable bollards, with a comprehensive range of products catering for vehicular access control and security applications.

Retractable Bollards hold distinct advantages over boom gates and other forms of vehicular access control as they provide much higher impact ratings and are pedestrian friendly. There are two application-based product lines, each offering a range of diameters in both mild steel (galvanised or electrostatically powder coated) and stainless steel models.

ADVANTAGES

1. A single key-locking mechanism ensures quick and easy access to restricted areas.
2. The clean and versatile design is highly visible and available with alternative mountings for consistent aesthetics that suit any modern building or landscape.
3. High-quality with surface treatment features high resistance to corrosion and weathering. Posts ship standard with 1 of 4 colored reflector stripes.



type 1

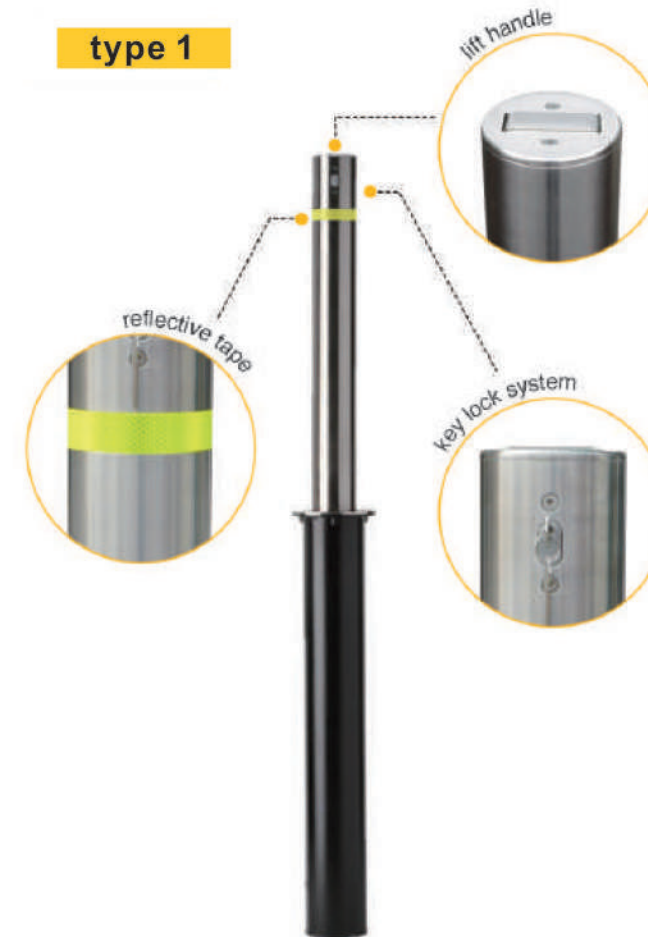

Advantage

- Lifted easily.
- Economical and easy to install.
- High resistance to corrosion and weathering.
- High security anti-theft locking mechanism.
- 3M diamond level reflective tape for warning.
- Color and material can be customized.
- One year standard warranty.

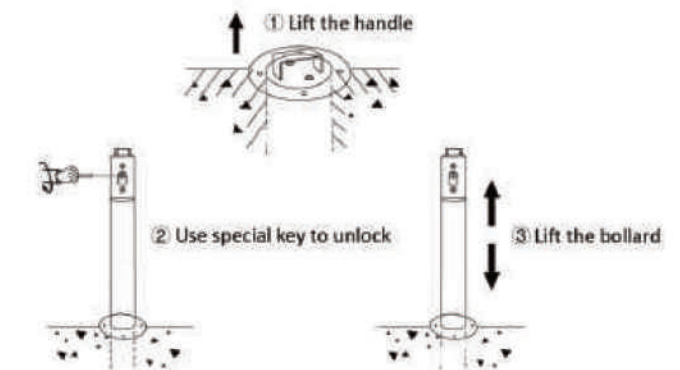
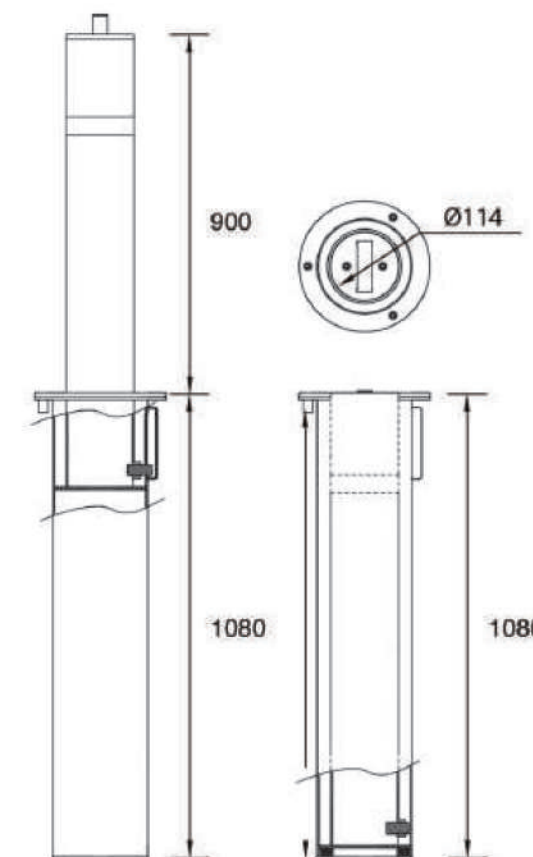

Technical Specs-type1

Model Name	KVS-RCB(I0)-114.900.3
Diameter	114mm
Height	900mm
Thickness	3mm
Material	Carbon Steel/304SS/316SS
Handle Type	Standard
Lock system	Side Key-lock
Colour	Yellow/Black/Sliver
Surface Treatment	Carbon Steel: Hot galvanizing and powder coated 304SS/316SS: Hairline Polish

type 2

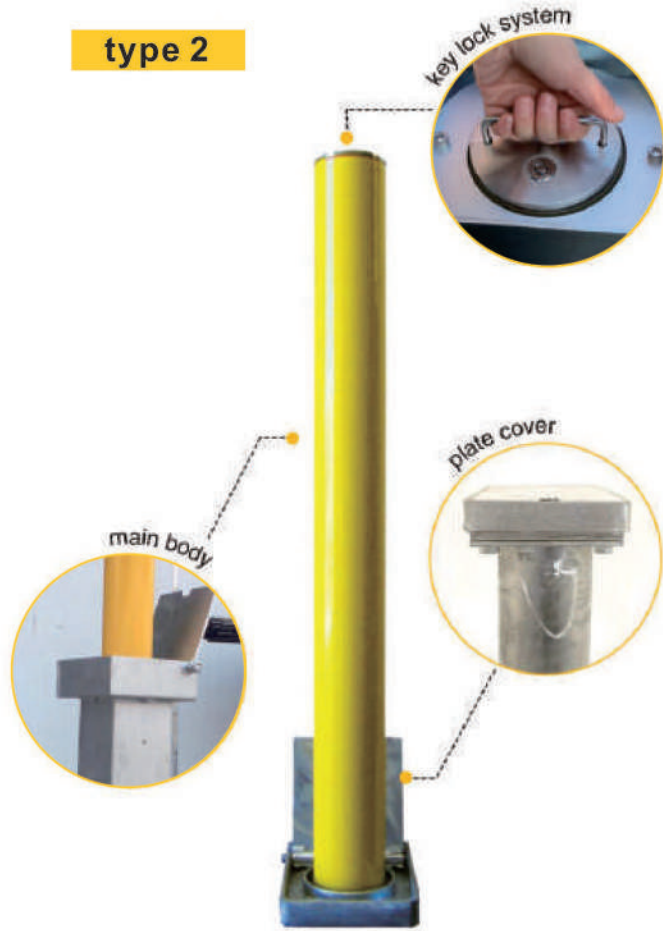

Features

- Rotate the top cap to lock and unlock the post.
- Easy operation
- Protective seal capping
- Double guide rods guarantee stable operation
- Finished with galvanized and powder coated. Hot galvanized only or powder coated only option available.

Optional

- Different color
- Different size

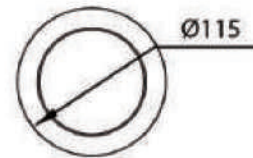
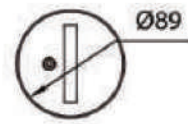
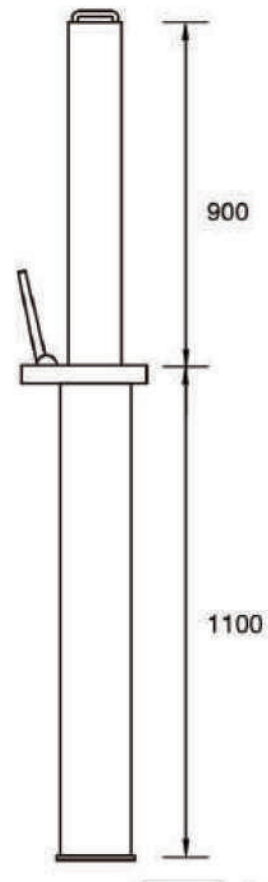

Specification				
Item No.	KVS-RCB-89.600.3-0	KVS-RCB-89.800.3-0	KVS-RCB-114.670.3-0	KVS-RCB-114.800.3-0
Diameter	89	89	114	114
Thickness	3	3	3	3
Height	600	800	670	800
Material	Carbon steel			
Surface finish	Finished with galvanized and powder coated. Hot galvanized only or powder coated only option available.			
Others	Other size can be customized on request. 304,316 grade stainless steel option available.			



Fold Down Bollard

KAVASS Folding down bollards are designed for protecting your parking space or stopping people turning around in your drive way. Bright yellow powder coating ensures high visibility for drivers.



FEATURE

1. Easy lift and fold down mechanism.
2. Integral lock –no need for additional padlock. Painted yellow for high visibility.
3. Simple to fit, full fitting instructions supplied.
4. Supplied with two keys as standard.
5. Available keyed alike or keyed to differ.

APPLICATION

1. Underground Parking lot
2. Personal parking space
3. Office Building

ADVANTAGE

1. Protect your private parking space
2. Someone could not takes up your parking space



type 1



Features

- Easy lift and fold down mechanism
- Integral lock –no need for additional padlock
- Painted yellow for high visibility
- Simple to fit, full fitting instructions supplied
- Supplied with two keys as standard
- Available for key alike or key different



type 2

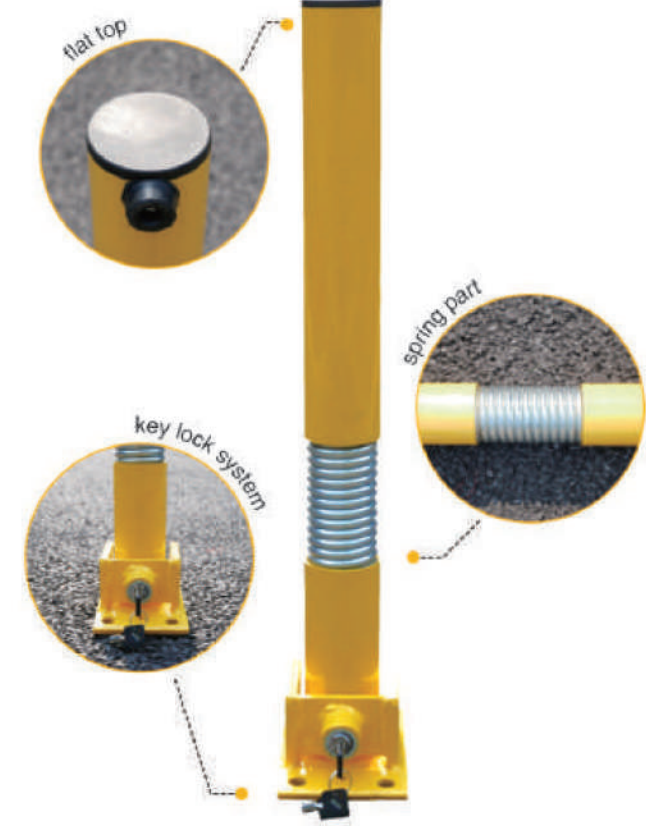

Features

- Integral lock system
- Easy installation and maintenance
- Lifted and fold down easily
- Reduce damage to Vehicle
- Supplied with two keys as standard

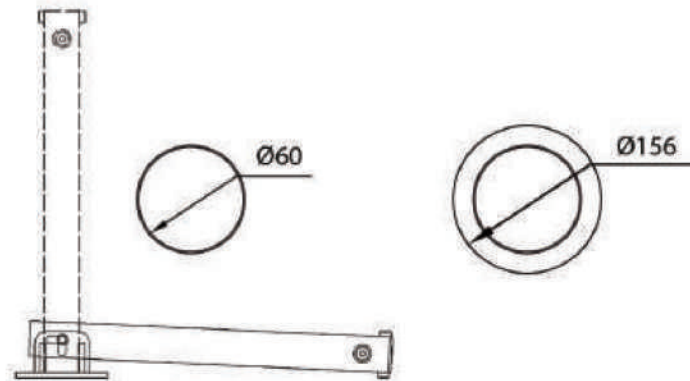
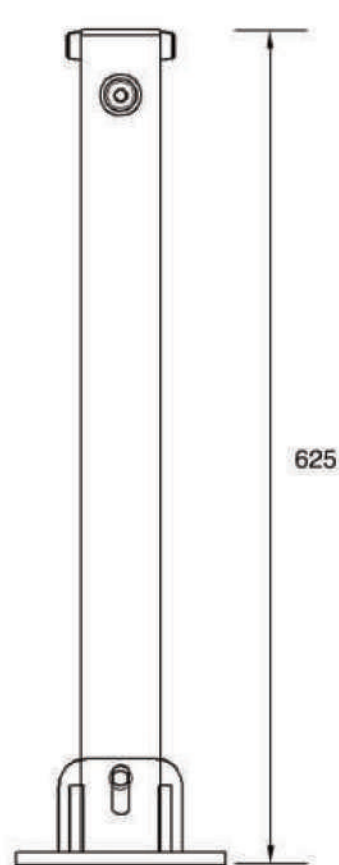

Technical Specs-type 1	
Model Name	KVS-FDB-60.610.3
Diameter	60mm
Height	610mm
Thickness	3mm
Material	Carbon Steel/304SS
Handle Type	Standard
Lock system	Side Key-lock
Colour	Yellow/Black/Sliver
Surface Treatment	Carbon Steel: Hot galvanizing and powder coated 304SS/316SS: Hairline Polish

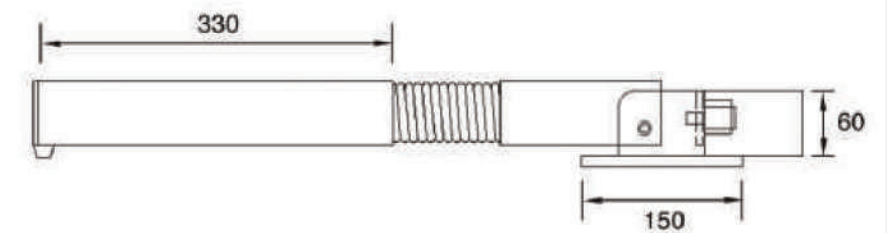
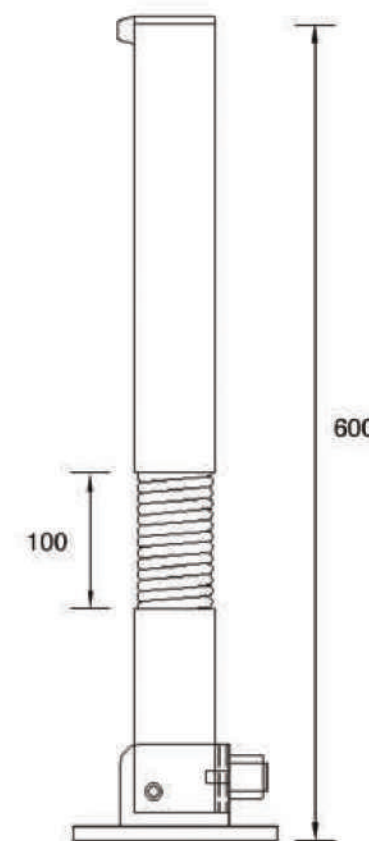

Technical Specs-type 1	
Model Name	KVS-FDB(S)-60.610.3
Diameter	60mm
Height	600mm
Thickness	3mm
Material	Carbon Steel/304SS
Handle Type	Standard
Lock system	Side Key-lock
Colour	Yellow/Black/Sliver
Surface Treatment	Carbon Steel: Hot galvanizing and powder coated 304SS: Hairline Polish

type 3



Features

- Stands 800mm tall when open
- Only 80mm high in the lay flat (closed) position
- Key lockable model includes two keys
- Hot galvanized and powder coated
- Low cost in installation and maintenance

Optional

- Padlock option available.

Specification		
Item No.	KVS-FDB(KP)-150.800.3-0	KVS-FDB(PP)-150.800.3-0
Length	150mm	150mm
Width	50mm	50mm
Thickness	3	3
Height	800	800
Lock system	Key-lock	Padlock(Sleevelock)
Material	Carbon steel	
Surface finish	Finished with Galvanized and powder coated Powder coated only option available.	
Others	Other size can be customized on request. 304 , 316 grade stainless steel option available.	

